

COOLEEDGE™

COOLEEDGE TILE INTERIOR ACOUSTIC - SPECIFICATIONS

PROJECT		REFERENCE TYPE	
SPECIFIED BY		QUANTITY	
DATE		NOTE	For Luminous Surfaces

SYSTEM OVERVIEW

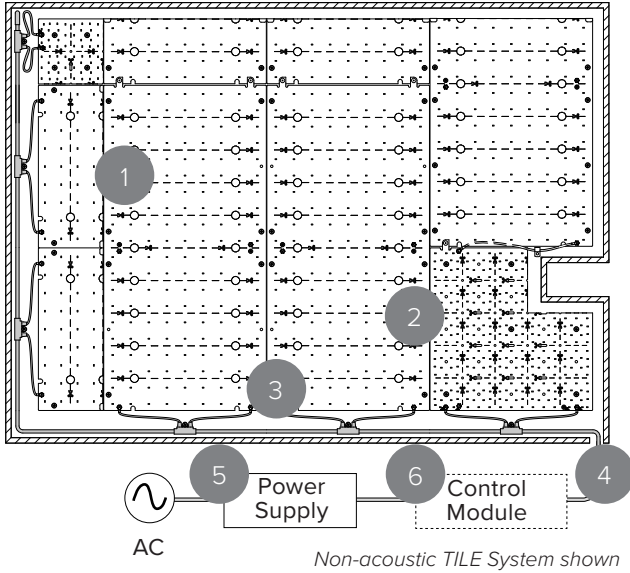

Create luminous ceilings, feature walls, and large graphics displays with Cooledge TILE Interior products

1	TILE Interior
2	TILE Interior Cut-out Kit - non-acoustic <i>(optional)</i>
3	TILE Interior T-Cable
4	TILE Interior Starter Cable*
5	Power Supply
6	Control Module <i>(optional)</i>

*Included in TILE Interior Starter Kit

GENERAL

Location	Indoor, dry location only
Operating Temp.	0-40°C (32-104°F)
Storage Temp.	-40-85°C (-40-185°F)
Relative Humidity	90% max (non-condensing)
Input Voltage (to power supply)	120-277 VAC
Electrical Connections	Tool-less snap connectors
Mounting Surface	Non-conductive* (drywall, plywood, etc)

*Mounting to a conductive surface may void warranty. Please contact Cooledge if this is required

FEATURES

- Four choices of constant lumen output ensure consistent highly calibrated illumination
- Color consistency of typically 2 SDCM between TILES meets stringent requirements for large area installations
- Cut-to-fit means systems are adaptable to any size installation and can accommodate obstacles and shapes
- Constant voltage electrical architecture is fully scalable without loss of performance or need to reconfigure drivers
- Low setback distances, flexibility, and no requirement for a heat sink enable optimal integration with luminous surfaces
- Multiple options for dimming, lumen level, and CCT offer the most adaptable illumination for large surface areas available today
- Mounts directly to most common non-conductive construction materials (eg. drywall, plywood)

SPECIFICATION

UL Listed lighting system inclusive of flexible light emitting sheets, connectors, low voltage cables, and LED drivers. Light output from the system must be +/- 10% of 900/600/300/150 lumens/sq ft across the total illuminated area post-installation. Color Rendering Index (CRI) must be >90 and color consistency between light sheets must be typical 2 SDCM. Electrical connections between cables and light emitting sheets must be tool-less and allow more than one connect/disconnect iteration. System must be configurable on-site and include the capability to accommodate obstacles, angles, and curves. System warranty is a minimum of 5 years.

Cooledge Lighting Inc.
110-13551 Commerce Parkway
Richmond, BC V6V 2L1 Canada

O +1 604 273 2665
F +1 604 273 2660
T +1 844 455 4448
W cooledgelighting.com

Cooledge Lighting reserves the right to change materials or modify the design of its product without notification as part of the company's continuing product improvement program.

COOLEDGE TILE INTERIOR ACOUSTIC - SPECIFICATIONS

PHOTOMETRICS¹

Light Output (lm/sqft)	900 ³ , 600, 300, 150
Correlated Color Temperature (CCT)	2200K, 2700K, 3000K, 3500K, 4000K, 5700K
Color Rendering Index (CRI)	≥ 90
Color Uniformity	2 SDCM (typical)
Lumen Maintenance ²	L80 = 75,000hr

¹ Photometric files available from cooledgelighting.com

² Based on LM80 data & TM-21 calculations

³ Not available in 2200K

POWER

Light Output (lm/sqft)	CCT	Power (W/sqft)	EcoDesign Class
900	2200K	N/A	N/A
	2700K	6.9	E
	3000K	6.3	D
	3500K	6.2	D
	4000K	6.2	D
	5700K	6.2	D
600	2200K	5.0	E
	2700K	4.6	E
	3000K	4.3	E
	3500K	4.1	D
	4000K	4.1	D
	5700K	4.2	D
300	2200K	2.5	E
	2700K	2.3	E
	3000K	2.2	E
	3500K	2.0	D
	4000K	2.1	D
	5700K	2.0	D
150	2200K	1.2	E
	2700K	1.1	E
	3000K	1.1	E
	3500K	1.0	D
	4000K	1.0	D
	5700K	1.0	D



IESNA TM-30-18 DATA

CCT	Rf	Rg
2200K	91	99
2700K	91	100
3000K	89	97
3500K	88	97
4000K	90	100
5700K	87	97

CERTIFICATIONS



ACOUSTIC PERFORMANCE

When Cooledge TILE Acoustic products are mounted to an acoustic backing material with a Noise Reduction Coefficient (NRC) rating of 1.0, Cooledge estimates that the resulting NRC value of the combined light emitting panel will be in the range of NRC = 0.5-0.7 depending on the surrounding environmental factors.

WARRANTY



5 Year Limited Warranty:
Parts and workmanship when used with a Cooledge approved power supply.

1 TILE INTERIOR ACOUSTIC

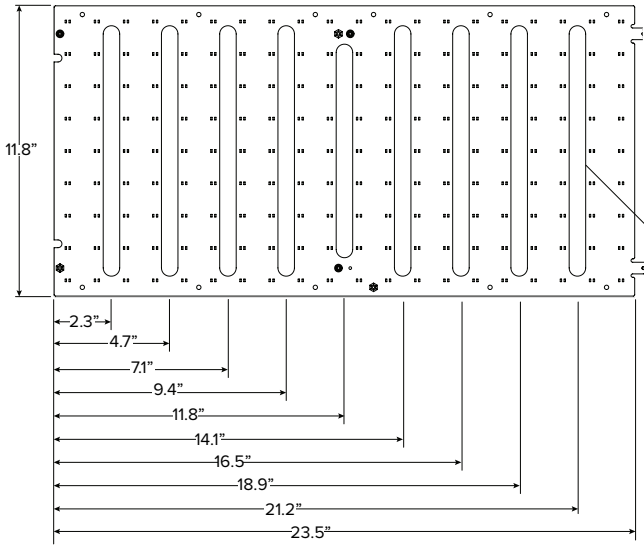

Weight = 0.18lbs/ 82g

Slots to allow sound transmission to acoustic materials

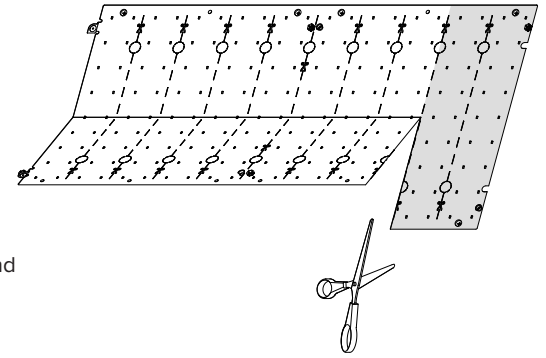

HOW TO ORDER

Example: TILE-INT-600-40-R3-A

TILE	-	INT	-	-	-	R3-A	
<u>PRODUCT</u> TILE		<u>TYPE</u> INT = Interior		<u>FLUX</u> 900 = 900lm/sqft 600 = 600lm/sqft 300 = 300lm/sqft 150 = 150lm/sqft		<u>CCT</u> 22 = 2200K 27 = 2700K 30 = 3000K 35 = 3500K 40 = 4000K 57 = 5700K	<u>Version</u> R3 = Revision 3 Acoustic

2 TILE INTERIOR CUT-OUT KIT (NON-ACOUSTIC)

Purpose: Cut-to-fit around obstacles located in the middle of a luminous surface such as standoffs, support cables/rods, beams, pipes, etc.; used in corners where a full TILE does not fit in the space; or to step cut along angles and curves in a luminous surface. (Optional)

INCLUDED

- (1) Cut-out TILE (11.81"x 11.81")
- (2) Insulating Patches
- (1) Cable Clamp
- (1) Jumper Cable

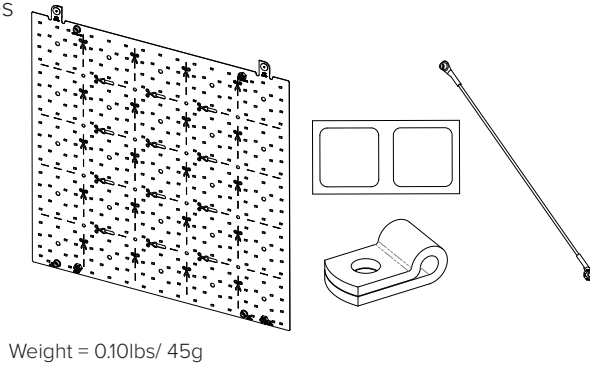

Weight = 0.10lbs/ 45g

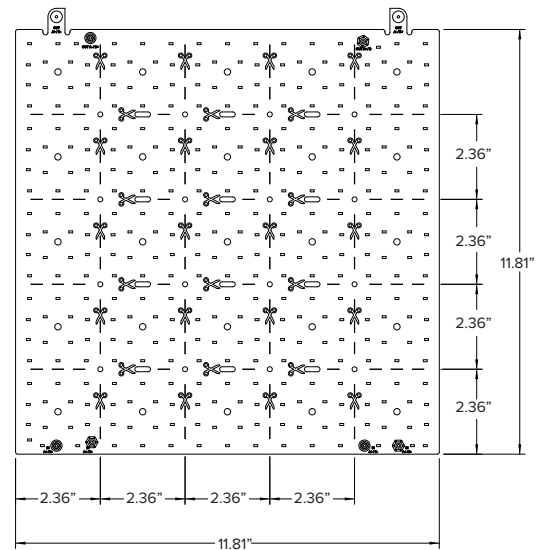

HOW TO ORDER

Example: TACC-INT-CUT-600-35-K-R3

TACC	-	INT	-	CUT	-	-	-	K	-	R3
<u>PRODUCT</u> TACC = TILE Accessory		<u>TYPE</u> INT = Interior		<u>COMPONENT</u> CUT = Cut-out Kit		<u>FLUX</u> 900 = 900lm/sqft 600 = 600lm/sqft 300 = 300lm/sqft 150 = 150lm/sqft		<u>CCT</u> 22 = 2200K 27 = 2700K 30 = 3000K 35 = 3500K 40 = 4000K 57 = 5700K		<u>VERSION</u> R3 = Revision 3

3 TILE INTERIOR T-CABLE

Purpose: Makes the electrical connection to the first TILE in each run from the Starter Cable that supplies power from the power/control components. Each “T” connects to a TILE via snap connectors. (Required)

HOW TO ORDER

Example: TCBL-SCT-T4

TCBL	-	
<u>PRODUCT</u> TCBL = TILE Cable		<u>TYPE</u> SCT-T4 = Static CCT, T-Connectors (weight = 0.13lb) SCT-T10 = Static CCT, T-Connectors (weight = 0.66lb)

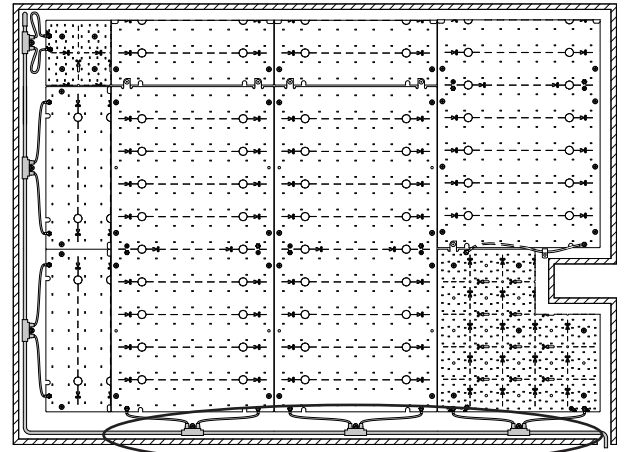

Note: non-acoustic version shown

4 TILE INTERIOR STARTER KIT

Purpose: Includes the Starter Cable that makes the connection from the Power/Control components to the T-Cable and other accessories required for wire termination and connections. Insulation patches are required to cover areas of TILES where cuts have been made. (Required)

INCLUDED

- (4) Cut TILE Reuse Jumper Cable
- (2) Splice Connectors
- (4) End Caps
- (10) Insulating Patches
- (1) 16 AWG (1.3mm²) Cable, 10 ft (3m) Length
- (1) Quick Start Guide

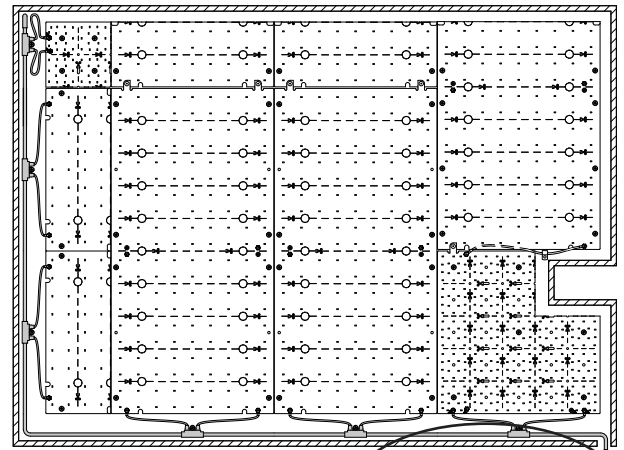
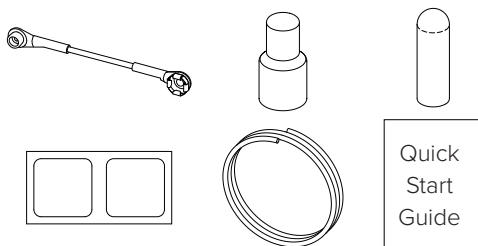

Note: non-acoustic version shown

HOW TO ORDER

Example: TACC-SCT-STR-K

TACC	-	SCT	-	STR	-	K
<u>PRODUCT</u> TACC = TILE Accessory		<u>CCT</u> SCT = Static Color Temp.		<u>TYPE</u> STR = Starter		<u>KIT</u> K = Kit

5 POWER AND CONTROL

Specifications for the power supplies and Cooledge Control Modules shown below are available in:

- Power and Control Specifications (UL Listed)

The models shown below are those that are compatible with TILE Interior Systems for regions where cUL Listed products are required.

POWER SUPPLIES (54V)

Purpose: Convert AC main (line) power to safe, low voltage DC power. (Required)

Order Code	Description	# Controller Channels*	Integrated Wiring Enclosure
EPSS-092-54V-UL	92W Power Supply, 54V (UL Listed) with integrated junction box	1	Yes
EPSS-200-54V-UL	200W Power Supply, 54V (UL Listed) with integrated junction box	2	Yes
EPSS-400-54V-UL	400W Power Supply, 54V (UL Listed) with integrated junction box	4	Yes

*Class 2 (max 90W) output

COOLEEDGE CONTROL MODULES (54V)

Purpose: Receives 54VDC power from the power supply and converts it to max. 90W per channel of controlled output to drive TILE Interior sheets. Also receives input control from one of 4 protocol options to control dimming levels. (Optional)

Order Code	Protocols
CTR-SCT-DAL/010-48/58V	0-10V, DALI
CTR-SCT-DMX-48/58V	DMX
CTR-SCT-CAS-48/58V	Casambi (wireless)

ADDITIONAL ACCESSORIES

EXTENSION CABLES

- 16 AWG cable (non-plenum rated)
- Available in 10' & 20' lengths

Purpose: Cable between TILE Starter Cable and Control Module that extends the distance the Control Module and power supply may be remotely located away from the TILES. Please consult Cooledge for additional information including requirements for plenum rated cables.

HOW TO ORDER

TCBL	-	
PRODUCT TCBL= TILE Cable	TYPE SCT-LNG-10 = Static CCT, Length = 10' SCT-LNG-20 = Static CCT, Length = 20'	

